

UEI

TEST INSTRUMENTS™

K9206

Quintox Flue Gas Analyzer

INSTRUCTION MANUAL

ENGLISH

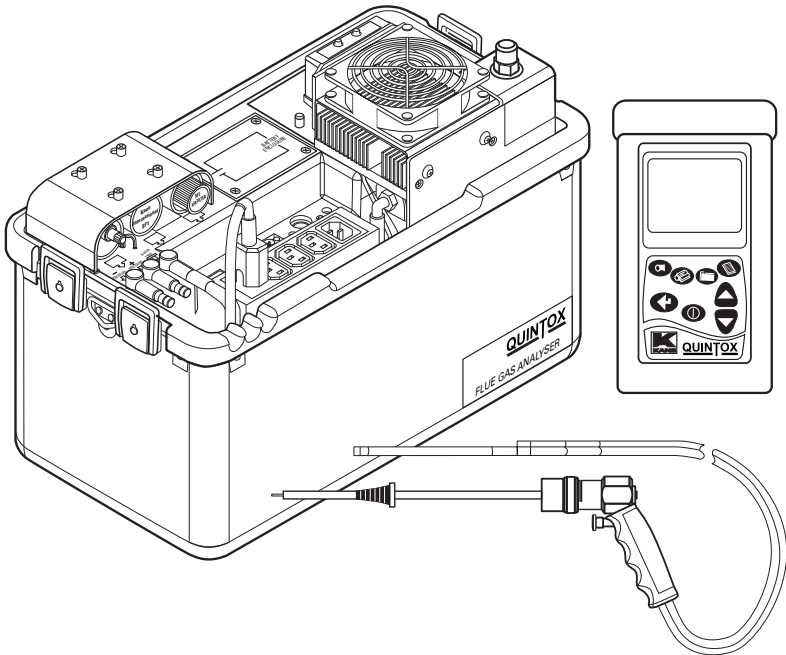

1-800-547-5740 • Fax: (503) 643-6322
www.ueitest.com • Email: info@ueitest.com

TABLE OF CONTENTS

K9206 OVERVIEW	5
Standard features	5
Handset	5
Main analyzer unit	5
OPTIONS	6
Electrochemical sensors	6
Other options	6
Probe options	6
Spare parts list	6
K9206 WITH KANE LIVE PC SOFTWARE	7
ANALYZER LAYOUT AND FEATURES	8
Handset features	8
Analyzer layout	9
Analyzer layout with KMDM220 gas conditioning Module fitted	10
Typical probe configuration (KM CSP6)	11
Analyzer connections	12
GETTING STARTED	12
Before taking readings	12
Menu: all the options	13
STATUS: ESTABLISHING THE ANALYZER'S SET-UP	14
SETUP: CONFIGURING THE ANALYZER'S SET-UP	16
Language	16
Main purge	17
Printer	17
Auto set time	18
Set time	18
Set date	19
Heater status	19
Select analyzer unit serial number	19
Bluetooth set up	19
Bluetooth passkey	19
ANALYZER UNITS: CONFIGURES ALL THE DATA SOURCES AND SETTINGS	20
Fuel origin	20
Fuel type	20
Efficiency	20
Gas units	20
Temperature	20
Pressure	21
Set percentage reference	21
Set NO _x calculation	21
Conversion factors	21

TABLE OF CONTENTS

CO ALARM	22
CO alarm set	22
CO alarm level	22
SCREEN	22
Contrast	22
Back light timer	22
Mode	22
Lines	23
REPORTS: CONFIGURES REPORTS	23
View reports	24
Delete all reports	24
Auto log time	24
Start auto log	24
Start auto printing	24
Header 1	24
Header 2	24
Form feed	25
Recertification	25
Manual air zero	25
Manual pressure zero	25
BEFORE USING THE ANALYZER FOR THE FIRST TIME	25
Safety warning	25
First time use	25
NORMAL START UP SEQUENCE	26
Every time you use the analyzer	26
Automatic calibration	26
MAIN MEASUREMENT SCREEN	27
In small font mode	27
In large font mode	28
SAMPLING THE FLUE GAS	30
LONG TERM MONITORING	30
KMDM220 GAS CONDITIONING MODULE	31
Setting up KMDM220	31
MAINTENANCE	32
Emptying and cleaning the in-line water trap	32
Changing the particle filter	32
Charging the battery	33
Changing the paper roll	33
To start paper feed	33
Changing the printer ribbon	33
PROBLEM SOLVING	34
HOW TO GET EXPERT HELP	35
END OF LIFE DISPOSAL	35

TABLE OF CONTENTS

BATTERY DISPOSAL	35
ANNUAL RECERTIFICATION	35
RETURNING YOUR ANALYZER	35
Packing your analyzer	36
Sending your analyzer	36
When we receive your analyzer	36
PRODUCT SPECIFICATION	37
Unit	37
Optional IR module	38
Handset	38
Extension cable	38
Main battery and optional heater battery	38
Battery charger	39
Pump	39
Integral printer	39
Ambient operating range	39
Heated line: KMHL3000	39
Heated probe: KMHP1200	39
Gas conditioning module: KMDM220	39
Probe	39
Optional portable printers	39
APPENDICES	40
A. PARAMETER MEANINGS	40
B. NO_x CALCULATIONS	42
ONLY AN NO SENSOR FITTED	42
Working in ppm: NO _x referenced to NO	42
Working in mg/m ³ : NO _x referenced to NO or NO ₂	42
Working in mg/m ³ : referenced to NO	42
Working in mg/m ³ : NO _x referenced to NO ₂	42
Normalizing readings	42
BOTH NO AND NO₂ SENSORS FITTED	43
Working in ppm: NO _x = NO + NO ₂	43
Working in mg/m ³	43
NO _x = SUM	43
NO _x = NO	43
NO _x = NO ₂	43
Normalizing readings	43
ONLY AN NO₂ SENSOR FITTED	43
Normalising readings	43
HIGH CO PURGE OPERATION	44
C. COMBUSTION EFFICIENCY CALCULATION	44
D. CALCULATION OF FUEL DATA	46
E. ELECTROMAGNETIC COMPATIBILITY (CE) STATEMENT	47

K9206 OVERVIEW

The K9206 is broadly based on the KM9106 and while retaining many of its core features has been significantly enhanced. The most visible difference is the large graphical display on the handset. Up to 15 lines of text/data can be displayed. The handset links to the main analyzer unit using Bluetooth or the normal cable. It also has a USB connector to link to a PC via a cable and has an infrared output to link to the portable KMIRP printer.

The main analyzer unit also contains significant enhancements over the previous 9106.

STANDARD FEATURES:

- 19301 Battery charger
- 18277 UK mains lead
- 18276 EU mains lead
- 18275 US mains lead
- 17136 Instruction manual
- KANE LIVE software downloadable at www.ueitest.com website

HANDSET: KBHS

- Bluetooth and cable connectivity to analyzer unit.
- Bluetooth and USB connectivity to PC
- GPS location
- IR connectivity to KMIRP and IRP-2 portable printer
- Large data storage memory (64k records)
- Graphical display with choice of large or small fonts.
- Battery rechargeable via main unit or main charger

MAIN ANALYZER UNIT: AS STANDARD K9206/P

- **Measures:** Oxygen, Ambient temperature, Atmospheric pressure, Inlet temperature
Flue temperature, Differential pressure
- **Features:** Main purge, Flow control*, NiMh battery packs, Plain paper printer

***Flow control**

To compensate for different suction levels in flues, hose lengths and filter contamination levels, all of which can affect the flow of sample gases, there is an active flow control system fitted to the K9206.

It operates as follows:

Every time the instrument is turned on and finishes its first fresh air purge cycle from inside the analyzer, it measures and records the pump pressure just prior to the sensor manifold while the pump is at 100% flow rate. During service calibration & normal use, the pump speed is automatically adjusted to 70% of the purge flow rate to maintain consistent flow.

The flow control can cope with typically 100 mbar suction in a flue and still maintain the same nominal flow as that present under ambient conditions.

OPTIONS:

ELECTROCHEMICAL SENSORS : (UP TO 5 SENSORS)

CHOOSE FROM:

- KC01/Q carbon monoxide (H₂ compensated)
- KN01L/Q Nitric oxide (low range)
- KN01H/Q Nitric oxide (high Range)
- KN02/Q Nitrogen dioxide
- KS02L/Q Sulphur dioxide (low range)
- KS02H/Q Sulphur dioxide (high range)
- KH2S/Q Hydrogen sulphide

OTHER OPTIONS:

- KHSA Heater for toxic sensors
- KHC/Q IR triple bench (CO, HC, CO₂)
- KHPUR/Q High/low CO protection (solenoid and pump)
- WTS9206P Pumped water trap
- KMHL3000 Heated line
- KMHP1200 Heated probe
- KMDM110 Gas conditioning module

SPARE PARTS LIST:

- OS11 Oxygen Sensor
- DP12 Printer ribbon (5) and paper (10)
- DP20 Printer paper (20 rolls)
- SF1 Chemical filter
- KMAF2 Particle filter assembly
- PF2/10 Particle filter ten pack
- WN8 Water trap filter pack
- BP9206 Battery pack
- WTS9106 Water trap assembly
- 19403 Peri pump tubing

PROBE OPTIONS:

- SM10617 Probe handle & hose
- 10051 Standard probe shaft
- 15589 2000° 12" Probe shaft
- 15588 36" Standard probe shaft
- 15590 2000° 36" Probe shaft

K9206 WITH KANELIVE PC SOFTWARE

KANELIVE is a free download that runs on Windows based PCs and allows live display and graphing of data. It can be downloaded from the UEI Test Instruments website www.ueitest.com.

- In the current configuration, the handset needs to be connected to the main unit by a cable and the Bluetooth setting for the handset needs to be changed to TO PC using MENU, SETUP, BLUETOOTH SETUP.
- Once this has been selected, go to the PC and select MY BLUETOOTH PLACES.
- Click ADD A BLUETOOTH DEVICE.
- All Bluetooth devices within range will be displayed in icon form. The K9206 handset will be displayed as: K9206HS
- 999999107 where the 9 digit number is the serial number of the handset.
- Double click on this. Now follow the instructions.
- Then enter the passkey: 1111
- Click on the TICK BOX and then AT SERIAL CONFIGURE and then FINISH.
- Now click on KANELIVE to initiate the program.
- Select your analyzer type by clicking on the analyzer name displayed on the middle of the bottom line of the screen. If more than one analyzer has been enabled a drop down will appear. Click on the analyzer of your choice.
- Then click CONNECT and wait for its color to change to green.
- Then click START, which will change to green.
- After a few seconds live data will be displayed.

ANALYZER LAYOUT AND FEATURES

HANDSET FEATURES

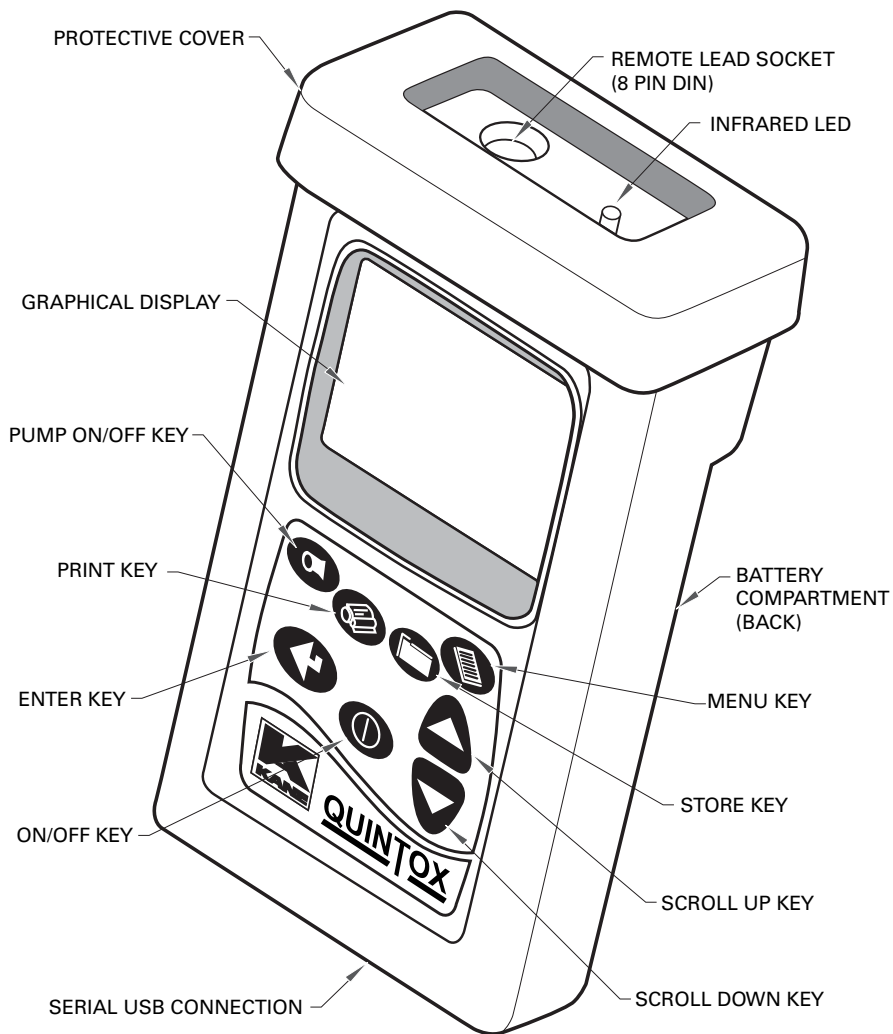

ANALYZER LAYOUT AND FEATURES

ANALYZER LAYOUT

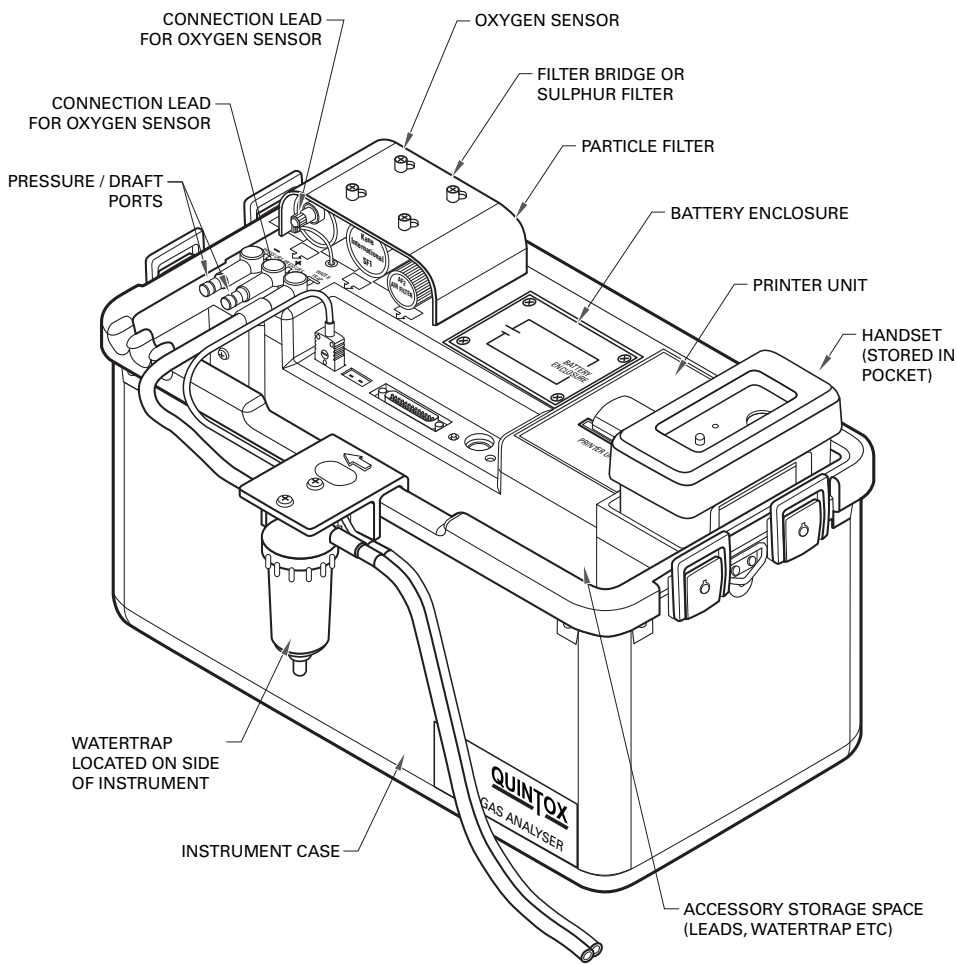

ANALYZER LAYOUT WITH KMDM220 GAS CONDITIONING MODULE FITTED

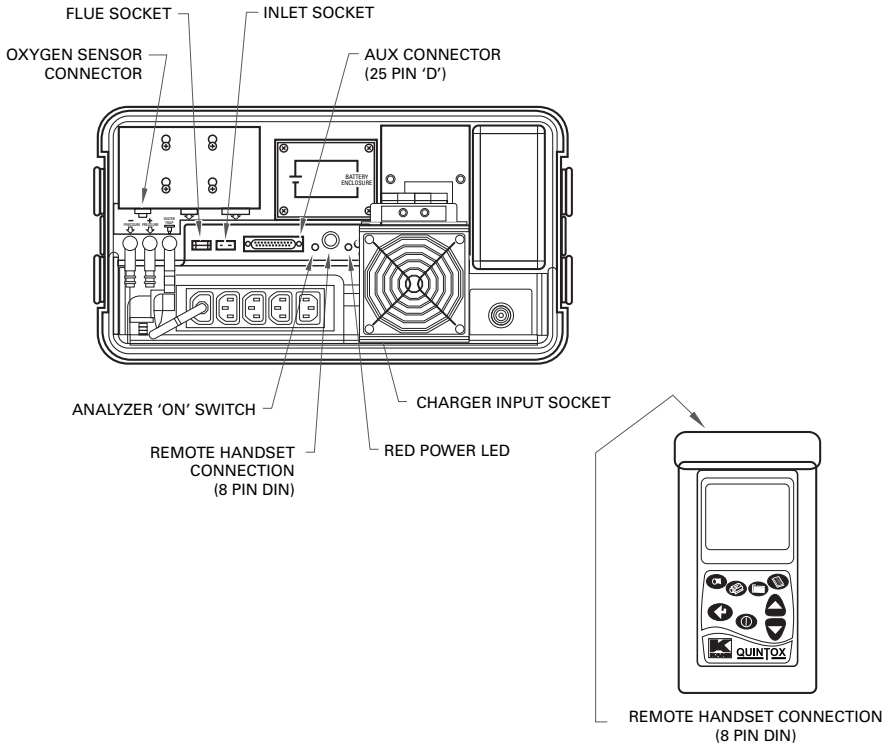
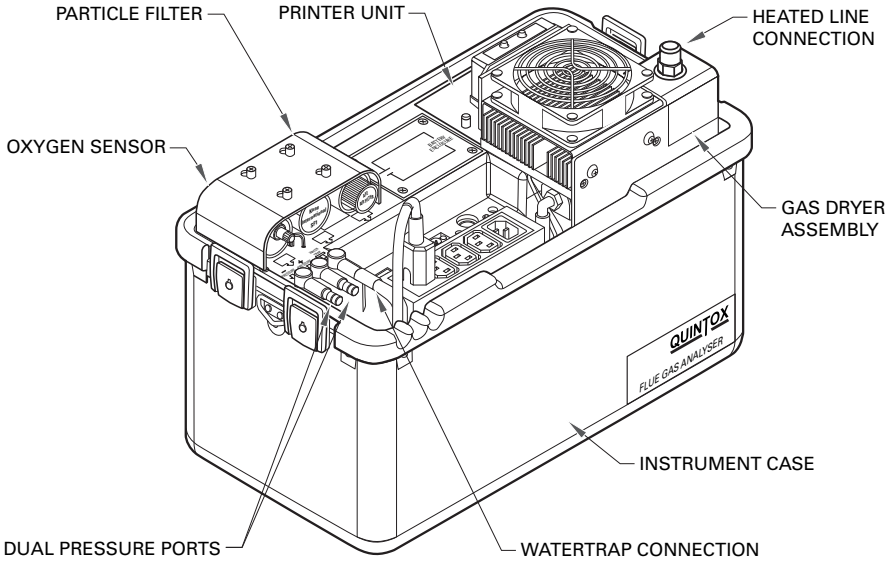

TYPICAL PROBE CONFIGURATION (KMCP6)

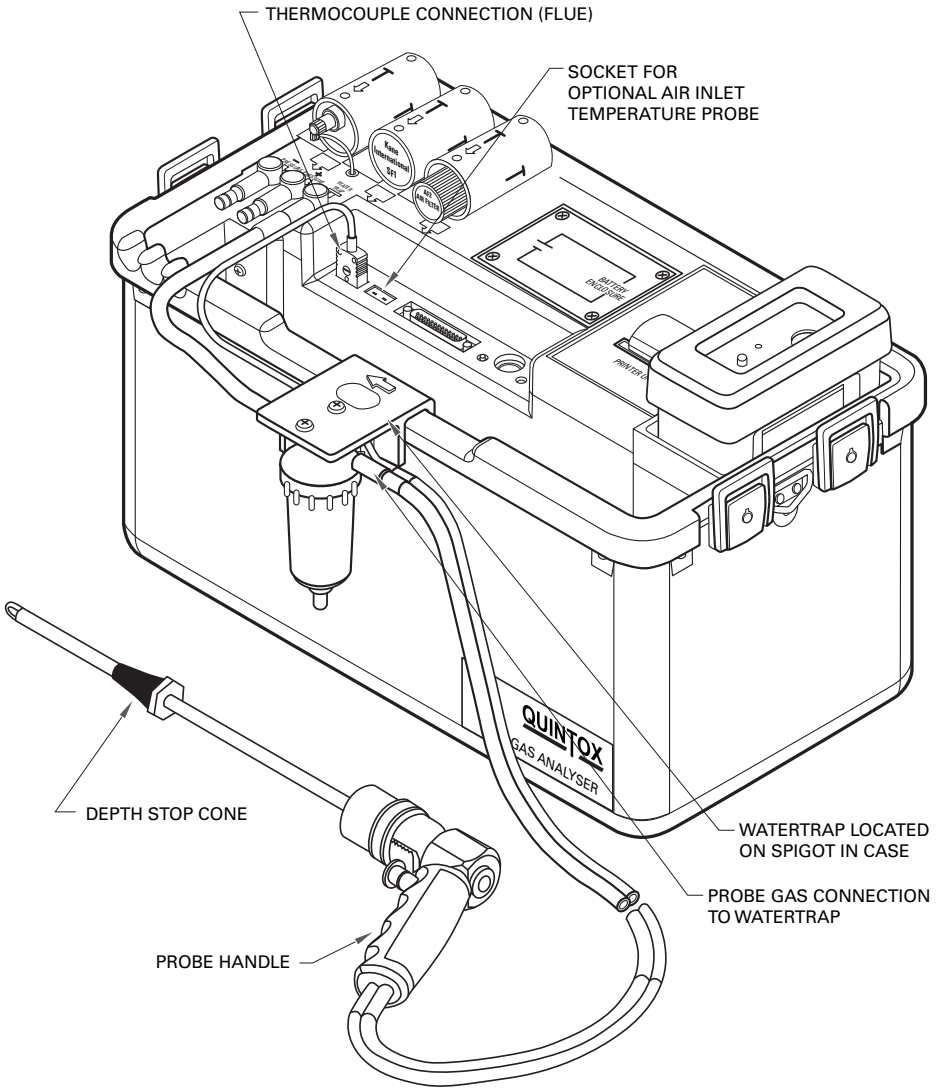

ANALYZER CONNECTIONS

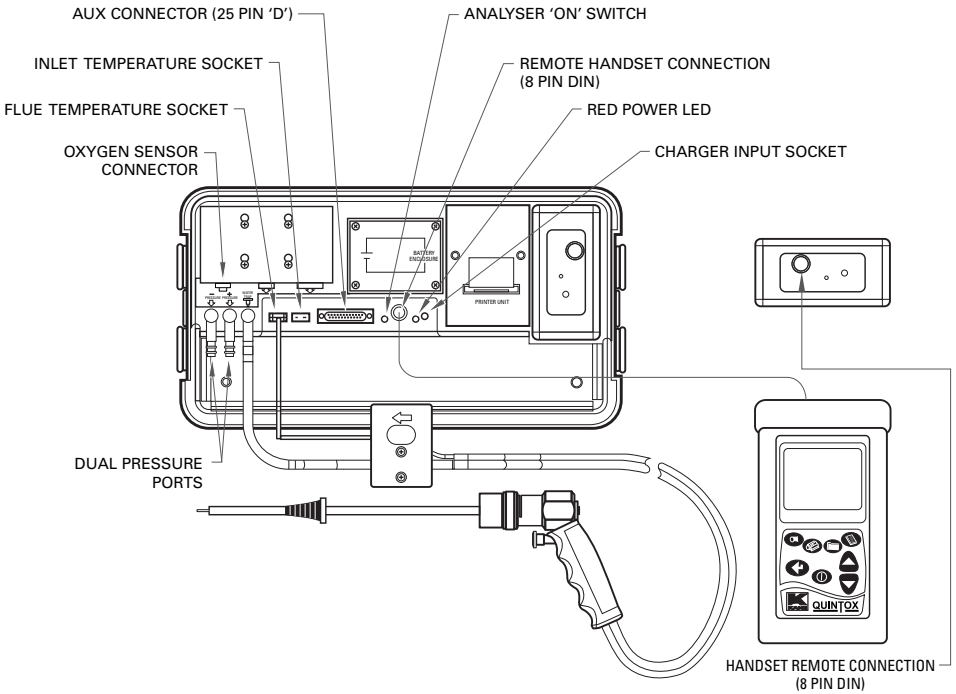

GETTING STARTED

- Check that you have all the items you have ordered.
- Before attempting to use the analyzer to take readings it is recommended that the batteries be fully charged.
- When the charger is connected to the analyzer and powered up the red LED by the charger socket will flash until the batteries are fully charged. Once the batteries are fully charged the LED will no longer be illuminated.
- To charge the handset; connect the handset to the main analyzer unit using its cable.

While switched off, but charging, the display will show the Kane logo and a battery charging icon in the bottom right hand corner of the handset screen.

Note: The handset battery is charged via the external battery charger and not from the analyzer's internal battery. Once the handset battery is fully charged the icon will disappear from the screen. The handset can also be charged directly using the main charger as used for the analyzer.

BEFORE TAKING READINGS

You need to establish the current set up of the analyzer and then you can customize to suit your testing needs.

Press the MENU key and then select STATUS as described below.

MENU: ALL THE OPTIONS

- Press the MENU key.

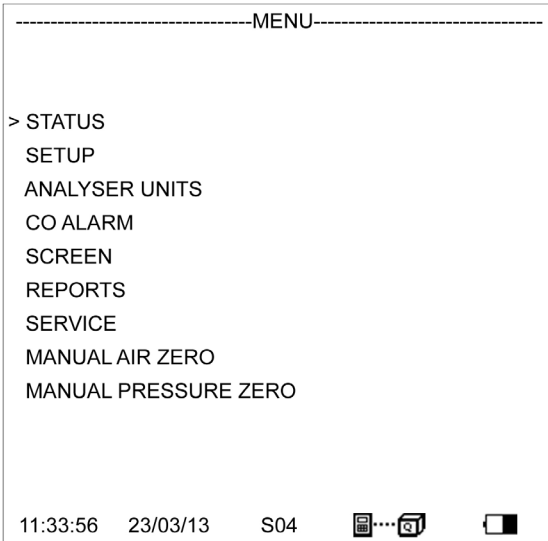

The > symbol acts as the cursor. It can be moved up or down by pressing the UP or DOWN keys.

Having made a selection press the ENTER key.

The bottom line of this screen lists:

- the time
- the date
- the number of satellites being received
- the Bluetooth connection status
- the estimated charge in the handset battery

STATUS: ESTABLISHING THE ANALYZER'S SET-UP

Press MENU and then select STATUS by pressing ENTER.

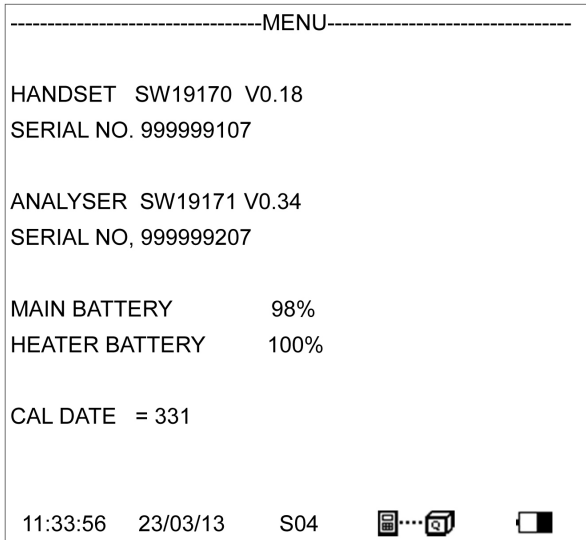

This screen lists :

- the software version in the handset
- the handset serial number
- the analyzer unit software version number
- the analyzer unit serial number
- the estimated charge in the main battery
- the estimated charge in the heater battery (if fitted)
- the number of days before annual re-calibration is due

Press DOWN to move to the next screen.

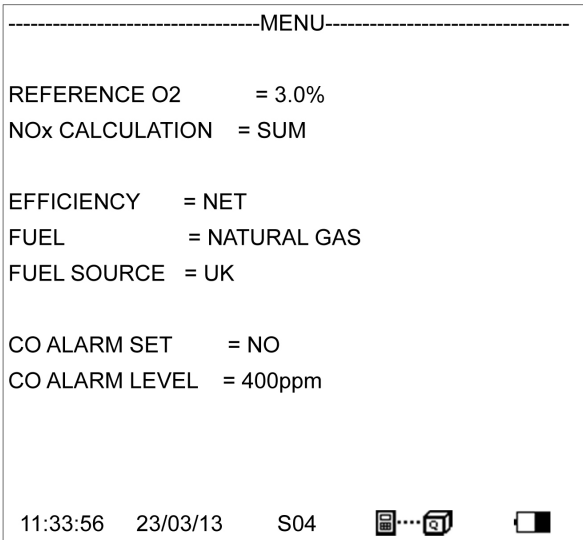

- Press DOWN to move to the next screen.

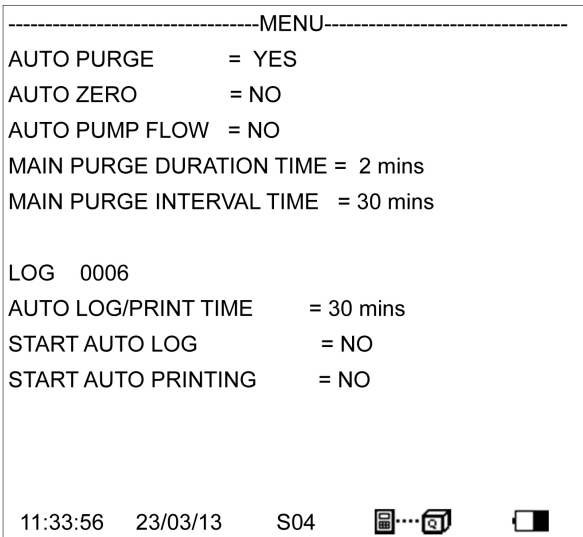

- Press DOWN to move back to the first screen.
- Press PRINT to print this status on the analyzer's printer.
- Press MENU to EXIT.

SETUP: CONFIGURING THE ANALYZER'S SETUP

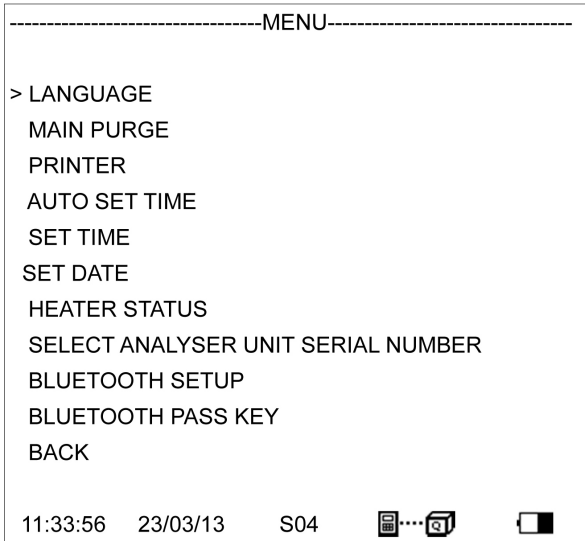

LANGUAGE:

- Align cursor using UP or DOWN keys, then press ENTER.
- Use UP or DOWN keys to scroll through the selection.
- Press ENTER to select.

MAIN PURGE:

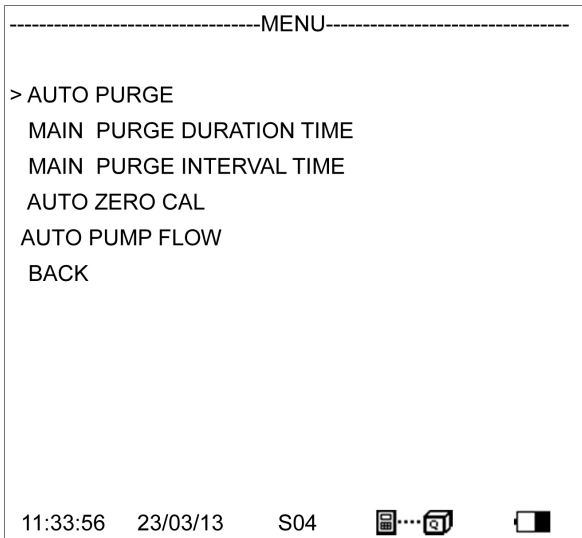

- AUTO PURGE: Set YES or NO
- AUTO PURGE DURATION TIME: Set fresh air purge duration to between 2 and 30 minutes.
- MAIN PURGE INTERVAL TIME : Set the interval between fresh air purges to between 10 and 120 minutes.
- AUTO ZERO CAL: Set YES or NO to automatically re-zero sensors at the end of a main purge cycle.
- AUTO PUMP FLOW: Set YES or NO to automatically control the pump flow. This may be required for some regulatory test protocols.

After switch on, the first purge interval is automatically set to 10 minutes if the optional IR module is fitted. Changes in the purge interval are implemented after completion of the next purge cycle. To implement a change immediately perform a "MANUAL AIR ZERO".

PRINTER:

This sets the destination for outputs from the handset.

The choices of outputs are:

- KMIRP
- IRP-2
- ANALYZER PRINTER
- SERIAL
- BLUETOOTH

Use UP or DOWN keys to scroll through the selection. Press ENTER to select,

AUTO SET TIME:

This function is locked if reports have been stored. To allow the function to operate, delete the reports. This allows the time to be set automatically from the GPS signals. Select NO to maintain manual setting.

Use UP or DOWN keys to scroll through the selection. Press ENTER to select,

SET TIME:

This function is locked off if "AUTO SET TIME" is activated or reports have been logged. If this function is locked, delete the reports.

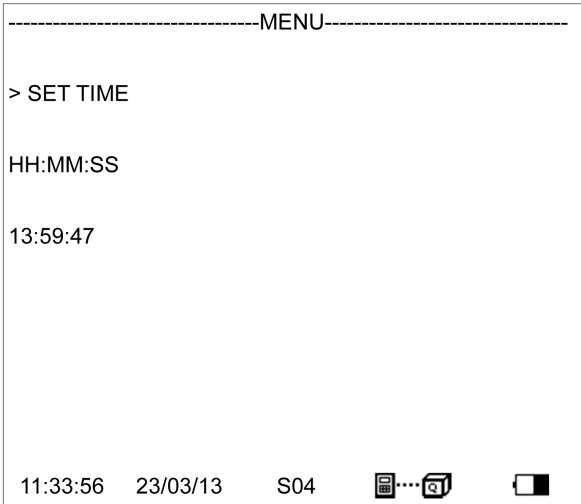

If manual setting is enabled use UP or DOWN keys to change values.

Press ENTER to select.

SET DATE:

This function can only be set manually, not by GPS.

If this function is locked, delete the reports.

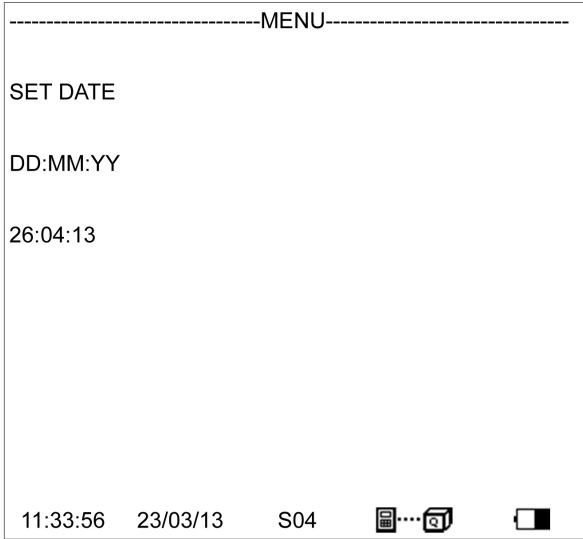

If manual setting is enabled use UP or DOWN keys to change values.

Press ENTER to select.

HEATER STATUS:

Switch off heaters or operate automatically.

Use UP or DOWN keys to scroll through the selection. Press ENTER to select.

SELECT ANALYZER UNIT SERIAL NUMBER:

If more than one analyzer unit is within Bluetooth range the handset needs to be set to communicate with the correct unit.

Use UP or DOWN keys to scroll through the selection. Press ENTER to select.

BLUETOOTH SET UP:

The handset can communicate with an analyzer unit or a PC. Bluetooth can also be switched off and a cable can be used.

Use UP or DOWN keys to scroll through the selection. Press ENTER to select.

BLUETOOTH PASSKEY:

This confirms the Passkey setting.

The Bluetooth Passkey is 1111.

ANALYZER UNITS:

CONFIGURES ALL THE DATA SOURCES AND SETTINGS

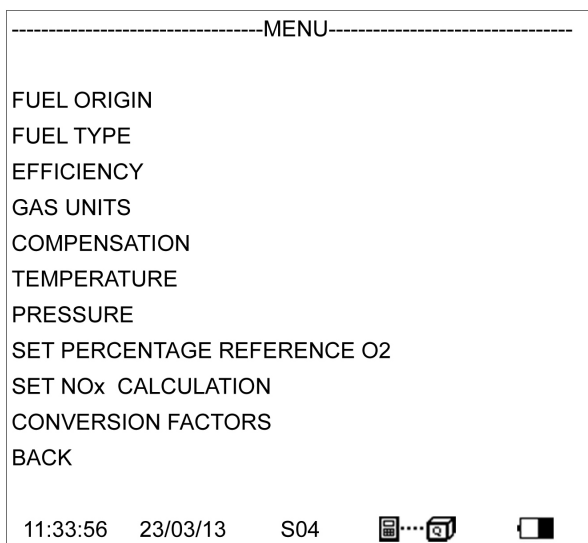

FUEL ORIGIN:

- Select from a list of country specific fuel tables.
- Use UP or DOWN keys to scroll through the selection. Press ENTER to select,

FUEL TYPE:

- Select from the list of fuel types associated with the chosen origin. The K values for the selected fuel are also shown.
- Use UP or DOWN keys to scroll through the selection. Press ENTER to select.
- There are 5 User Fuels that can be loaded from a PC. The title of these user fuels can be edited using the keypad on the handset.
- Use UP or DOWN keys to scroll through the selection. Press ENTER to select.

EFFICIENCY:

- Select NET or GROSS, condensing net, condensing gross efficiency calculation
- Use UP or DOWN keys to scroll through the selection. Press ENTER to select.

GAS UNITS:

- Select ppm or ppmn or mg/m3 or mg/m3n.
- Use UP or DOWN keys to scroll through the selection. Press ENTER to select.

TEMPERATURE:

- Allows the selection of Fahrenheit or Celsius.
- Use UP or DOWN keys to scroll through the selection. Press ENTER to select.

PRESSURE:

- Allows the selection of pressure units.
- Select from: mbar, In H2O, mm H2O, hPa, psi.
- Use UP or DOWN keys to scroll through the selection. Press ENTER to select.

SET PERCENTAGE REFERENCE O2:

- Can be set between 0% (equivalent to OFF) and 10%.
- Use UP or DOWN keys to scroll through the selection. Press ENTER to select.

SET NOx CALCULATION:

- Select from: SUM, NO2 or NO
- Set REFERENCE NOx to the percentage required or defined by local regulations. Typically 5% NO2 is added to an NO reading. The value can be user set.
- SUM adds the readings from an NO sensor and an NO2 sensor when fitted
- NO calculates an NOx reading from the NO reading where $NOx = NO \times 1.1$
NO2 calculates an NOx reading from the NO2 reading where $NOx = NO2 \times 2.05$
- Use UP or DOWN keys to scroll through the selection. Press ENTER to select.

CONVERSION FACTORS:

Display the Propane Equivalency Factor PEF and the Methane Equivalency Factor for the IR module (if fitted) and the pitot factor – change from 0.10 to 1.00 as determined by the pitot tube being used.

CO ALARM:

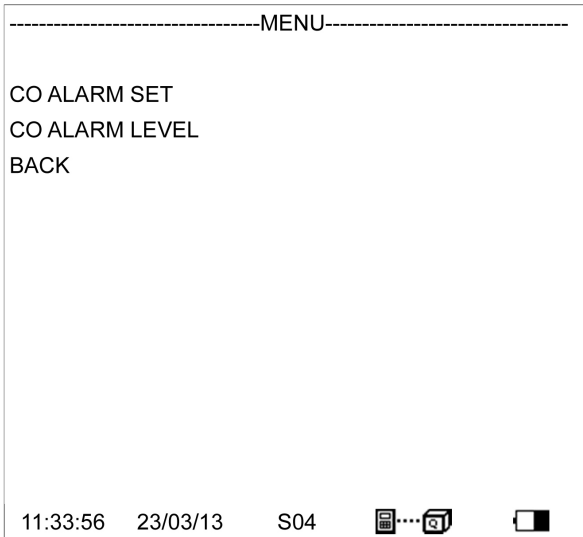

CO ALARM SET:

- Switch the alarm ON or OFF.
- Use UP or DOWN keys to scroll through the selection. Press ENTER to select.

CO ALARM LEVEL:

- Allows a specific CO level in ppm to be set as the alarm trigger point.
- Use UP or DOWN keys to change the digits. Press ENTER to select and move to the next digit.
- The display will show '+++' when the CO alarm is triggered.

SCREEN:

The screen display is fully configurable.

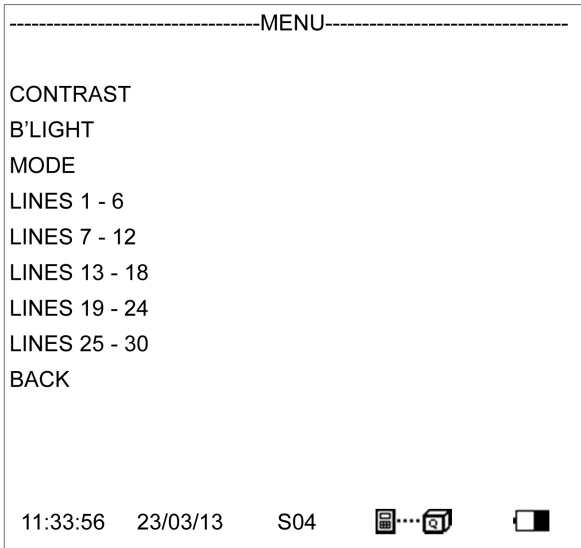

CONTRAST:

- Allows the display to be darkened or lightened. Default value is 14.
- Use UP or DOWN keys to change the digits. Press ENTER to select and move to the next digit.

B'LIGHT:

- The switch off time for the backlight can be set for between 30 and 300 seconds,
- Use UP or DOWN keys to change the digits. Press ENTER to select and move to the next digit.
- During normal measurements press ENTER to switch the backlight on.

MODE:

- The main display can be set for SMALL font or LARGE font.

LINES:

- This feature allows users to customize the screen display to suit their own requirements.
- Use UP or DOWN keys to change the selection. Press ENTER to select and move to the next digit.
- So for Lines 1-6, the screen shows:

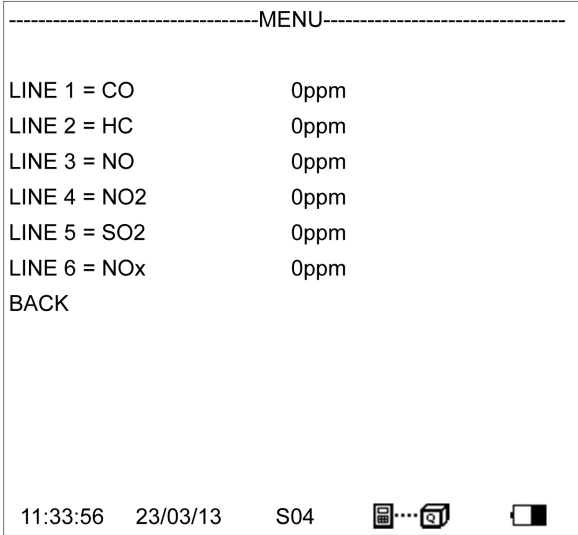

- The parameter to be displayed on each line can be individually selected.
- Use UP or DOWN keys to change the selection. Press ENTER to select and move to the next digit.

REPORTS: CONFIGURES REPORTS

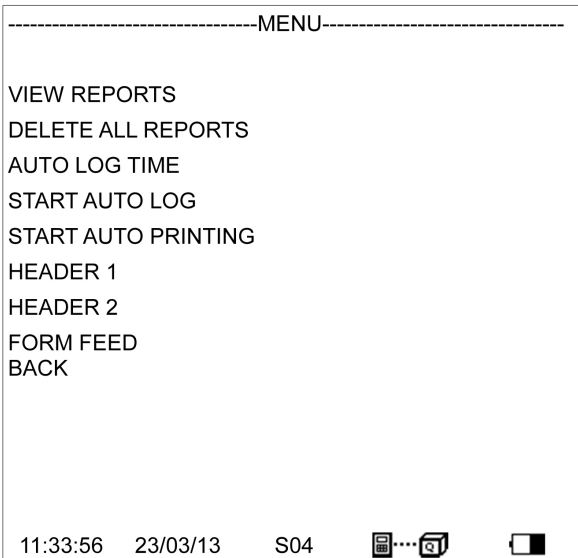

VIEW REPORTS:

- This selection displays a 'main screen' with a LOG number near the top left hand of the display.
- This number can be changed using UP or DOWN and the display automatically changes.

-----MENU-----			
LOG	0000		
DATE	00/00/00	TIME	12:00:00AM
ORIGIN	UK	FUEL	NATURAL GAS
O2	0.00%	CO2	0.0%
CO	0ppm	NO	0ppm
NO2	0ppm	NOx	0ppm
SO2	0ppm	H2S	----ppm
O2	19.98%	FLUE	0.0deg C
INLET	0.0deg C	AMBIENT	0.0deg C
NETT	0.0deg C	LOSS	10
DRY	0	WET	10
11:33:56	23/03/13	S04	

DELETE ALL REPORTS:

- All reports can be deleted. A confirmation YES is required.
- Use UP or DOWN keys to scroll through the selection. Press ENTER to select,

AUTO LOG TIME:

- Automatic logging/printing can be selected for intervals between 10 seconds and 90 minutes.
- Use UP or DOWN keys to scroll through the selection. Press ENTER to select,

START AUTO LOG:

- Select YES or NO.
- Use UP or DOWN keys to scroll through the selection. Press ENTER to select,

START AUTO PRINTING:

- Select YES or NO.
- Use UP or DOWN keys to scroll through the selection. Press ENTER to select,

HEADER 1: 16 CHARACTERS

- Allows the printed header line: YOUR COMPANY to be changed.
- Use UP or DOWN keys to change the characters. Press ENTER to select and move to the next character.

HEADER 2: 16 CHARACTERS

- Allows the printed header line: NAME & PHONE number to be changed.
- Use UP or DOWN keys to change the characters. Press ENTER to select and move to the next character.

FORM FEED:

- Allows remote paper feeding on printers.

RECERTIFICATION:

- CODE: For use by authorized service agents.
- CAL DATE = number of days before annual recertification is due.

MANUAL AIR ZERO:

- Select this and press ENTER to initiate a fresh air purge and sensor zeroing

MANUAL PRESSURE ZERO:

- Select this and press ENTER to re-zero the pressure sensor

BEFORE USING THE ANALYZER FOR THE FIRST TIME.**SAFETY WARNING**

This analyzer extracts combustion gases that may be toxic in relatively low concentrations. These gases are exhausted from the bottom of the instrument. This instrument must only be used in well-ventilated locations. It must only be used by trained and competent persons after due consideration of all the potential hazards.

FIRST TIME USE

Charge the batteries for 12 hours; following this an overnight charge should be sufficient for an average 8-hour day. There may be three battery packs that need charging, the main battery, the optional heater battery and the handset battery. The handset battery can use the same charger as the analyzer unit or can be charged via the main unit using a handset lead. All batteries are NiMh.

- While charging the red LED will flash.
- We offer a wide choice of probes, which are not supplied as standard and must be ordered as a separate item.
- Take time to read this manual fully.

TIP: *Take a look at the Spare Parts list and order some replacement filters and paper rolls now.*

NORMAL START UP SEQUENCE

EVERY TIME YOU USE THE ANALYZER

BEFORE SWITCH-ON CHECK THAT:

- the oxygen sensor is connected
- the particle filter is not dirty
- the sulphur filter is fitted for heavy oil or coal
- the water trap and probe line are empty of water
- all hose connections, etc, are properly made
- the paper roll is fitted
- the analyzer unit is in fresh air
- the water trap is vertical
- the flue temperature is connected
- the instrument is placed on a clean, flat, level surface

Switch ON the analyzer by pressing ON/OFF on the handset. **You also need to press the ON/OFF switch on the analyzer main unit.**

AUTOMATIC CALIBRATION

- During this sequence the analyzer pumps fresh air into the sensors to allow toxic sensors to be set to zero and the oxygen sensor to be set to 20.9 %.
- During this sequence the handset display will show the following:

```
Kane Quintox  
  
SW 19170   v0.18  
  
SERIAL NO. 999999107  
  
BLUETOOTH CONNECTING .....
```

Note: *The software version number and serial number are examples only.*

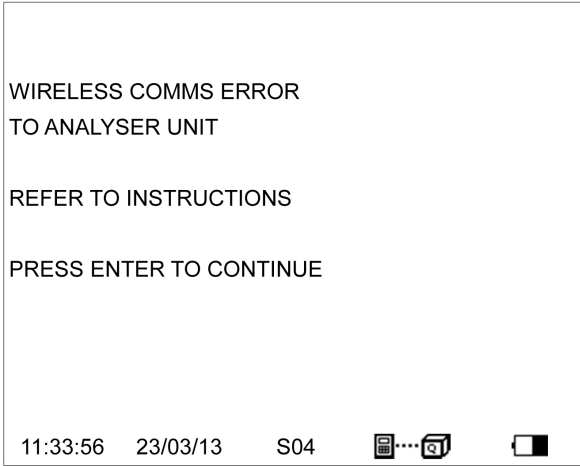

If there is no Bluetooth communication between the handset and the main unit the following will appear on the screen.



- Press ENTER to continue and follow the instructions.
- Once Bluetooth communication is established the main measurement screen will appear.

MAIN MEASUREMENT SCREEN

IN SMALL FONT MODE

ZERO TIME 60M			
CO2	----%	NETT	-N\F-deg C
HC	----ppm	LOSS	----
CO	0ppm	DRY	----
NO	0ppm	WET	-N\F-
NO2	0ppm	CO LOSS	0%
NOx	0ppm	P INDEX	0.00%
SO2	0ppm	CO/CO2	R0.0000
H2S	----ppm	EFF (G)	----%
O2	19.98%	XAIR	----%
FLUE	-N\F-deg C	PRESSURE	0.00mbar
INLET	20.3 deg C	ATM	986.6mbar
AMBIENT		GPS (X)	-00011.458
11:33:56	23/03/13	S04	  

- TOP LINE: shows status messages
- GASES: O2 and CO2 are shown in % other gases shown in ppm or other user selected units CO can be shown in % if optional IR bench is fitted
- TEMPERATURES: displayed in C or F. N\F = not fitted
 - occurs for calculations when N\F applies
 - occurs when a calculation cannot be made due to an out of range value (Eg zero)
- Atmospheric pressure (ATM) is always displayed in mbar.

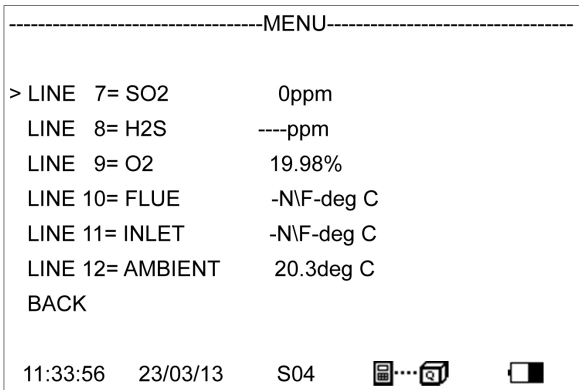
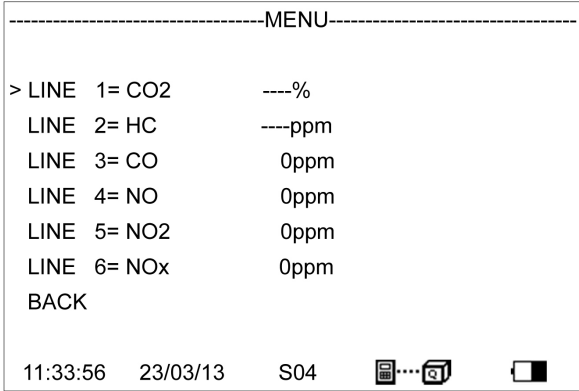

IN LARGE FONT MODE

There are 5 screens that are accessed using the UP or DOWN keys





-----MENU-----

> LINE 13= NETT -N\F-deg C
 LINE 14= LOSS ----
 LINE 15= DRY ----
 LINE 16= WET -N\F-
 LINE 17= CO LOSS 0%
 LINE 18= P INDEX 0.00%
 BACK

11:33:56 23/03/13 S04   



-----MENU-----

> LINE 19= CO/CO2 R0.0000
 LINE 20= EFF (G) ---%
 LINE 21= XAIR ---%
 LINE 22= PRESSURE 0.00mbar
 LINE 23= ATM 986.6mbar
 LINE 24= GPS (X) -00011.458
 BACK

11:33:56 23/03/13 S04   

-----MENU-----

> LINE 25= GPS (Y) +5148.0957
 LINE 26= MAIN BAT 24%
 LINE 27= HEAT BAT 100%
 LINE 28=
 LINE 29=
 LINE 30=
 BACK

11:33:56 23/03/13 S04   

SAMPLING THE FLUE GAS

Once the automatic calibration procedure has been completed and the specific fuel has been selected the probe can be inserted into the desired sampling point.

It is recommended that the sampling point be located at least two flue diameters downstream of any bend and that the probe tip is in the center of the flue (this is normally the point of the hottest temperature). With balanced flues and other industrial units the probe should be positioned far enough into the flue so that no air can 'back flush' into the probe.

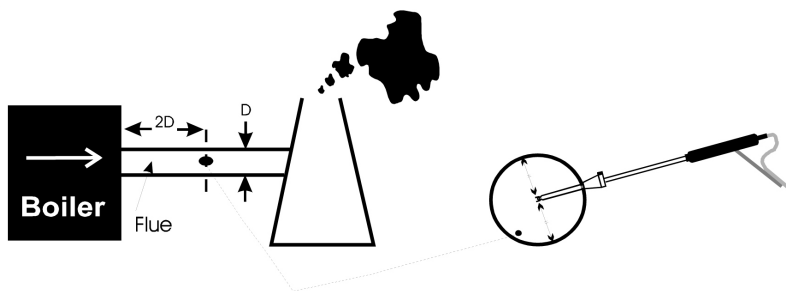

The probe depth stop cone provided with the instrument allows the probe to be used in holes whose diameters range from 8 mm to 21 mm (5/16 to 4/5 inch).

The standard probe is rated at 650°C/1202°F. Temperatures of up to 100°C/2012°F can be accommodated using an optional high temperature probe.

TIP: To conserve battery power, switch off the pump when you are not taking a measurement. Use the pump key to turn the pump ON and OFF.

LONG TERM MONITORING

There are a number of things that need to be considered for successful long term unattended monitoring:

- The provision of enough power for the duration of the test
- The capability to empty the water trap
- Regular fresh air purging of the sensors
- **Protection from rain or water spray from the process being monitored.**



If a mains power source is being used it is strongly recommended that the supply cable be protected by a suitable Residual Current Device (RCD).

Unless the water trap is to be regularly inspected then a pumped water trap should be fitted.

Electrochemical sensors need regular refreshing with fresh air, preferably at around 50% RH. They also need a small percentage of oxygen to be present in the sampled gas. If there is zero oxygen the output from the sensors will decay over time (10 minutes or so). In such circumstances, fresh air purge should be programmed for a 50% duty cycle every 10 minutes.

The longest sampling time without purging should be limited to 2 hours and then purge for 30 minutes.

When the KHC infrared module is fitted, for maximum accuracy it is recommended that purging occur every 30 minutes.

KMDM220 GAS CONDITIONING MODULE

This module is fitted in the front compartment of a standard K9206 carry case and comprises a Peltier fan cooled chiller assembly, a peristaltic pump to automatically remove condensate, the control electronics and a power supply module. The module is supported on an aluminum alloy chassis.

The chiller is connected to a flue mounted electrically heated probe (KMHP1200) by a 9.8 foot long heated line with automatic temperature control (KMHL3000). Because the gas that is extracted from the flue is maintained at 248°F no condensation occurs in the probe or the hose and so no sample gas is lost in the condensate. The chiller flash cools the sample gas to below the ambient dew point and any water in the gas immediately condenses. The condensate is then pumped away using a peristaltic pump. Because the gas has no chance to remain in contact with the condensate, volatile sample gas is not lost into the condensate. The chilled gas then naturally warms up as it passes through the sampling pump to the sensors and as it does so its humidity reduces and there is no risk of further condensation.

SETTING UP KMDM220

The heated sample probe must be connected to the top of the heated line and a gas tight connection be made without over tightening the connections. This joint must then be thermally insulated. Both the heated probe and the heated line must be connected to a mains power source via a suitable Residual Current Device (RCD) and be left powered up for 20 minutes to achieve their operating temperature before attempting to extract sample gas.

When the probe is inserted into the sampling point it must be suitably supported to prevent bending and unnecessary strain. Likewise the heated line should be carefully supported and never be twisted or kinked as this may damage the internal heating elements.

The heated line is connected to the chiller by attaching the end of the line to the through bulkhead connection in the K9206 carry case. A short flexible connection then links the hose to the chiller. The chiller needs to be powered up for at least 10 minutes before it is used.

The peristaltic pump operates automatically. Always check that the drain of the peristaltic pump is clear and that there are no blockages. The peristaltic pump needs to have its flexible rotor replaced after every 1000 hours of operation.

To operate efficiently the chiller needs to be well ventilated so the case lid must be removed, however the unit must be protected externally to prevent ingress of water from either the plant being tested or from rainfall.

MAINTENANCE

EMPTYING AND CLEANING THE IN-LINE WATER TRAP

The water trap should be checked and emptied on a regular basis. Water vapor will condense in the probe line, which may cause the water trap to fill beyond the maximum level mark. If this occurs water could be drawn into the analyzer causing damage. Care should be taken at all times to avoid this risk.

Emptying of the water trap is detailed below:

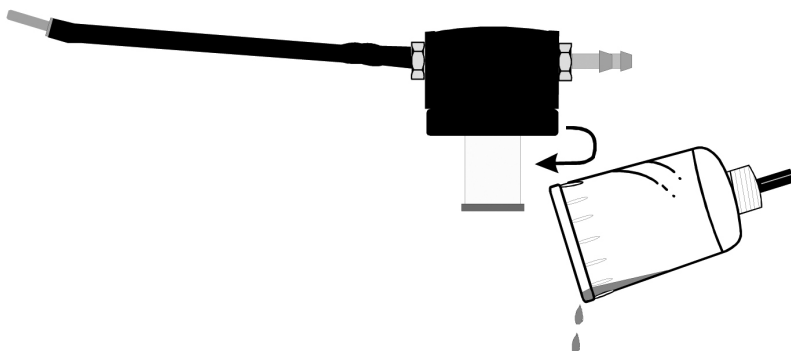

Carefully remove the end cap from the in-line housing. Dispose of the condensate in a suitable drain; care must be taken, as it could be acidic. If condensate spills onto the skin or clothing, clean off immediately using fresh water and seek medical advice if problems occur.

CHANGING THE PARTICLE FILTER

This is a very important part of the analyzer and should be changed regularly. It prevents dust and dirty particles entering the pump and sensors and hence causing damage. The filter **MUST** be changed when it appears discolored.

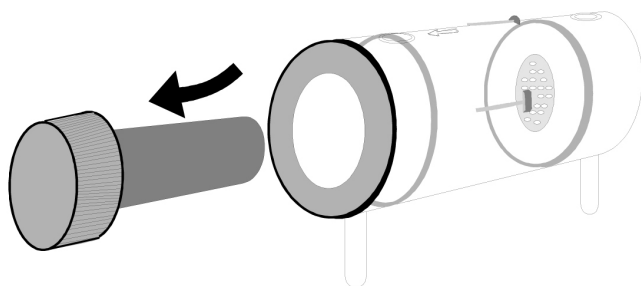

Remove the end cap from the filter housing. Carefully remove the paper filter element and dispose of it. Clean the inside of the filter housing with a suitable soft cloth. Insert a new filter element onto the spigot on the filter end cap and carefully insert it into the filter body.

CHARGING THE BATTERY

It is important that the battery is charged on a regular basis. The instrument constantly powers the internal sensors and may discharge the battery if left unattended for several months. Connect the charger supplied with the instrument to the correct mains supply.

Note: *The correct charger type may be required for your local voltage i.e. 110 or 220volts AC.*

Insert the plug in the socket marked CHARGER INPUT SOCKET

The CHARGER ON RED LED will flash showing the instrument is charging.

CHANGING THE PAPER ROLL

To change the paper roll, remove the printer cover by loosening the two screws holding it down. Remove the old paper roll core and insert the new roll so that it sits as follows:

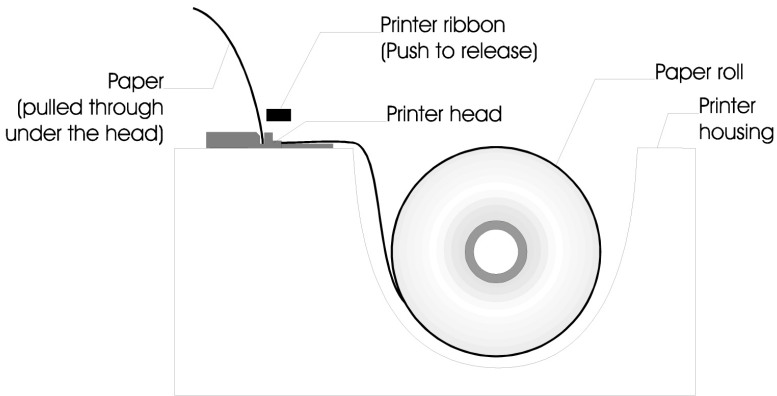

Feed the free end of paper into the printer through the metal slot beneath the printer ribbon. Start the paper feed sequence until the paper has emerged from the top of the printer, feed the loose end through the cover and refit.

TO START PAPER FEED

Go to MENU, REPORTS, FORM FEED

CHANGING THE PRINTER RIBBON

The printer ribbon cartridge will last for approximately two rolls of paper. Remove the printer cover as detailed above.

Marked on one end of the cartridge is PUSH. Gently press down on this end and the ribbon cartridge will pop up at the other end. Remove the cartridge and dispose of.

Fit a new ribbon guiding the paper roll between the exposed ribbon and cartridge body.

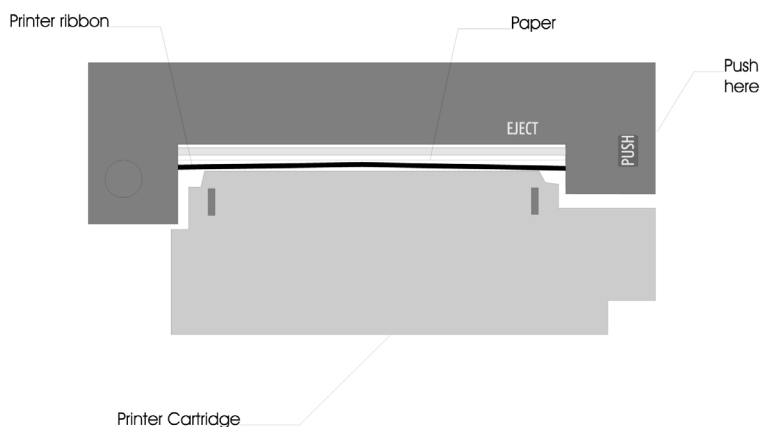

Refit printer cover.

PROBLEM SOLVING

The following is a list of problems that may occur on the instrument through its operating life. If the cause of the fault is not easy to identify then we advise you to contact the Kane International Service Department or an International Distributor for expert advice.

Fault symptom	Causes
Oxygen too high CO2 too low	Air leaking into probe, tubing, water trap, connectors or internal to instrument. Oxygen cell needs replacing.
Analyzer not holding charge Analyzer not charging	Battery exhausted. AC charger not giving correct output. Fuse blown in charger plug.
Analyzer does not respond to flue gas	Particle filter blocked. Probe or tubing blocked. Pump not working or damaged with contaminants.
Flue temperature readings erratic	Temperature plug reversed in socket. Faulty connection or break in cable or plug.
Analyzer automatically switches off in operation.	Battery below alarm level. Battery quickly discharging and is faulty.
Display is blank.	The contrast setting has been lost and requires resetting. Disconnect handset lead and reconnect. Set contrast as in MENU : SCREEN : CONTRAST

HOW TO GET EXPERT HELP

There will be occasions when despite having read the manual there will be problems that you cannot resolve and so you need external help.

Before calling UEi Test Instruments please check the following first:

Find the serial number of the instrument. It is located on the label close to where the charger and handset leads plug into the analyzer. Also make a note of which sensors are fitted by observing the tick marks on the instrument label.

If the handset and analyzer are operating you can also determine the issue of software loaded in the analyzer and its handset by viewing STATUS. If you can, take a printout of STATUS and a printout of the measurement screen so that they can be faxed or emailed to your technical support advisor.

END OF LIFE DISPOSAL

The Waste Electrical or Electronic Equipment (WEEE) Directive requires countries in the EU to maximize collection and environmentally responsible processing of these items.

Products are now labeled with a crossed out wheeled bin symbol to remind you that they can be recycled.

BATTERY DISPOSAL

All the user replaceable batteries used in this product are NiMh and are suitable for recycling through any local waste portable battery recycling scheme.

ANNUAL RECERTIFICATION

Although sensor life is typically more than five years, the monitor should be re-calibrated and serviced annually to help prevent any long-term sensor drift or accidental damage.

Local regulations may require more frequent re-calibration.

In the USA, UEi Test Instruments has recertification facilities at Beaverton, OR and Indianapolis, IN.

RETURNING YOUR ANALYZER TO UEi

When returning your K9206, contact customer service at 800-547-5740 or fill out our service request form at www.ueitest.com.

Please always ensure that you enclose:

- Your full contact details
- A daytime telephone number
- Details of faults you might have experienced
- Any relevant accessories (eg. Probe, printer, adaptor and leak detectors). Any accessories that are returned will be checked. If an accessory has failed then we will quote you for a repair or a replacement.

PACKING YOUR ANALYZER

When returning your analyzer, please pack it appropriately to prevent any damage during transit.

Before sealing your package, please ensure that you have enclosed the items listed above and that it is clearly marked for the attention of:

WWW.UEITEST.COM

PORTLAND, OR

Headquarters
Recertification Center
1-800-547-5740
info@ueitest.com

INDIANAPOLIS, IN

Recertification Center
1-800-547-5740
info@ueitest.com

VANCOUVER, BC

Recertification Center
ISO/IEC 17025:2005
NIST Certification
1-877-475-0648
infocanada@ueitest.com

SENDING YOUR ANALYZER

Once the analyzer has been securely packed then your package is ready for shipment back to UEi Test Instruments. If you do not have an account with a courier company you can take your package to your local Post Office. It is advisable to send the package by Special Delivery so that it is insured and traceable while in transit.

WHEN WE RECEIVE YOUR ANALYZER

On receipt of your package, our Service Engineers will inspect the analyzer and any accessories and confirm to you the total service cost. Once you have accepted this, the work will be carried out, and upon completion the analyzer returned to you.

If you have any questions that we haven't answered, please contact UEi:

1-800-547-5740 • FAX: (503) 643-6322
www.ueitest.com • Email: info@ueitest.com

PRODUCT SPECIFICATION

UNIT

Temp Measurement	Resolution	Accuracy	Range
Flue Temperature	0.1° (C/F)	1.0°C ± 0.3% of reading	0 - 1100°C 32 - 2140°F * Use high temperature probe for gases >600°C/1112°F
Inlet Temperature	0.1° (C/F)	1.0°C ± 0.3% of reading	0 - 600°C 0 - 999°F

Gas Measurement *1	Resolution	Accuracy	Range
Oxygen (O2):	0.1%	-0.1% +0.2% O2	0- 25%
Carbon monoxide (CO): (standard: H compensated)	1ppm	± 5ppm < 100ppm 5% of reading < 2000ppm ± 10% of reading >2000ppm	0 - 10,000ppm
Nitric oxide (NO): (high range)	1ppm	± 5ppm < 100ppm ± 5% of reading > 100ppm	0 - 5,000ppm
Nitric oxide (NO): (low range)	1ppm	± 2ppm < 30ppm ± 5ppm > 30ppm	0 - 100ppm
Nitrogen dioxide (NO2):	1ppm	± 5ppm < 100ppm ± 10ppm < 500ppm ± 5% of reading > 500ppm	0 - 1,000ppm
Sulphur dioxide (SO2) (low range):	1ppm	± 2ppm < 30ppm ± 5ppm > 30ppm	0 - 100ppm
Sulphur dioxide (SO2) (high range):	1ppm	± 5ppm < 100ppm ± 5% of reading > 100ppm	0 - 5,000ppm
Hydrogen sulphide:	1 ppm	± 5ppm < 100ppm ± 5% of reading > 100ppm	0 - 1,000ppm
Pressure:	0.01mbar	± 0.5% Full scale	0 - 150mbar
Carbon dioxide (CO2) *2:	0.1%	± 0.3% CO2	0 - Fuel Value
Efficiency *2:	0.1%	± 1%	0 - 100%

*1 using dry test gases at STP

*2 calculated

NB: all ppm reading can be displayed in mg/m3 and can be normalized

OPTIONAL IR MODULE

Hydrocarbons:			
Range:	Overrange	Accuracy	Resolution
0-5,000ppm	10,000ppm	+5% of reading and + 12ppm vol.	1ppm
CO₂:			
Range:	Overrange	Accuracy	Resolution
0-20%	40%	+5% of reading and + 0.5% vol.	0.1%
CO:			
Range:	Overrange	Accuracy	Resolution
0-10%	20%	+5% of reading and + 0.2% vol. <30%	0.1%

Response time T90:	30 seconds
Warm up time:	3 minutes
Operating temperature range:	5 to 50 deg. C.
Operating humidity:	10-80% non condensing
Power:	Supplied by K9206

Conversion Factors from a Propane Calibration	
Propane	multiply by 1
Methane	multiply by 0.1
Hexane	multiply by 2

HANDSET

Dimensions	8.66" long (220mm long) 4.72" high (120mm high) 1.96" wide (50mm wide)
Keypad	tactile keys
Display	graphical with backlight and contrast control

EXTENSION CABLE

Specification:	8 pin DIN cable
Cable lengths:	16' Standard 32'-65'-Optional

MAIN BATTERY AND OPTIONAL HEATER BATTERY

Type:	NiMH Rechargeable (12V, 2AH)
Life:	8 hours from full charge
Charge time:	12 hours trickle 4 hours fast charge

BATTERY CHARGER

Input:	100V-240V AC 60 watts
Output:	15V DC @ 4 amps

PUMP

Flow rate:	2 Liters/Minute nominal 500 mbar static suction
------------	---

INTEGRAL PRINTER

- 16 character dot matrix.
- Plain paper

AMBIENT OPERATING RANGE

- -10°C to + 55°C
- < 85% RH non condensing
- Storage: -10°C to 55°C

HEATED LINE: KMHL3000

- Power supply: 220V ac @ maximum 300 watts

HEATED PROBE: KMHP1200

- Power supply: 220V ac @ maximum 100 watts
- 1200mm insertion length, 8 mm diameter rated to 1000 o C

GAS CONDITIONING MODULE: KMDM220

- Power supply: 220 Vac @ 5 amps peak.

PROBE

- Choose from a range of probe options. See probe website.

OPTIONAL PORTABLE PRINTERS

- Compatible with KMIRP and IRP-2

APPENDICES

A – PARAMETER MEANINGS

The parameters and their meanings are detailed as follows : -

- DATE : Analyzer date.
- TIME : Analyzer time.
- MAIN BATTERY/
HEATER BATTERY: Displays the battery level from 0-100%. The analyzer will flash RECHARGE BATTERY at less than 10 % of charge. The analyzer may show levels greater than 100% when the charger is connected.
- ---- : Displayed when a calculation cannot be performed because a probe is not fitted or a parameter is out of range.
- FUEL : The fuel used in calculation of efficiency and carbon dioxide.
- K1g: Gross calorific fuel constant. See Appendix for calculation.
- K1n : Gross calorific fuel constant. See Appendix for calculation.
- K2 : Percentage Maximum theoretical CO₂ (dry basis).
- K3: Percentage wet loss.
- K4 : Percentage unburnt carbon loss.
- O2r : Toxic gas measurements can be referenced to defined oxygen levels. Oxygen referencing is required by some regulations such as TALUFT. If a reference value is selected the toxic gas measurements will be displayed with the symbol n attached to the units. i.e. ppmn
What does oxygen reference mean?
If 3 % O₂ reference is selected and 5 % O₂ is measured in the flue then toxic gas values will be recalculated as if 3 % were measured. The equation for referencing is detailed in the Appendix. Oxygen referencing prevents false readings being submitted, e.g. allowing more air into the boiler will increase the oxygen level in the flue and hence dilute any toxic gas reading. Oxygen referencing gives readings as if they were undiluted.
- NETT : Nett temperature calculated by deducting the internal AMBIENT temperature from the measured FLUE temperature. Displays in either Centigrade C or Fahrenheit F and will display NOT FITTED if flue probe not connected. If an external INLET probe is used then INLET is deducted from FLUE.
- O2 : Oxygen reading in percentage %.
- CO : Carbon monoxide reading indicated in ppm or mg/m³. If the figures are referenced to oxygen then the display will show ppmn or mg/m³n. Note with a high CO sensor fitted the reading will be displayed in percentage %.
- EFF (G) : Combustion Efficiency calculation displayed in percentage. Gross (G) or Net (N) can be set. The calculation is determined by fuel type see Appendix for calculation. The efficiency is displayed during a combustion test, 00.0 is displayed while in fresh air.
- CO2: Carbon dioxide reading in percentage % when measured, not calculated
- CO2c: Carbon dioxide calculation determined by the type of fuel. This only shows a reading when a combustion test is being carried out. Zero (0.0) is displayed while in fresh air.

- FLUE : Temperature measured by flue gas probe in Centigrade or Fahrenheit. Will show ambient temperature after fresh air calibration and NF if probe disconnected.
- INLET : Temperature measured by the optional inlet air probe or stored using the Flue probe. The air probe is plugged into the instrument through the INLET socket. This figure is used to calculate the NET temperature instead of AMBIENT when fitted. Will show NF if not fitted.
- AMBIENT : Temperature measured by the internal sensor, used in the NET temperature
- CO/CO2 R : The CO/CO2 ratio, is the ratio of measured CO divided by CO2. It gives an indication of the following :- How good a gas sample the instrument is reading. How clean the boiler is running. For example : A new or clean domestic boiler will display a ratio of less than 0.004, a unit in need of cleaning 0.0040-0.0080 and a unit in need of major overhaul will show greater than 0.008. This only shows a reading when a combustion test is being carried out. 0.0000 is displayed while in fresh air.
- P INDEX : The CO/CO2 ratio expressed as a percentage %, called the 'Poison Index" i.e. P INDEX % = 100 x CO/CO2. 0.00 is displayed while in fresh air.
- XAIR % : Excess air calculated from the measured oxygen and type of fuel used. Displays reading during a combustion test +++ is displayed while in fresh air.
- PRESSURE: Pressure reading. Units can be changed to different scales.
- NO: Nitric oxide reading in ppm or mg/m3. Displayed when nitric oxide sensor fitted. Reading can also be referenced to oxygen ppmn or mg/m3n.
- NO2: Nitrogen dioxide reading in ppm or mg/m3. Displayed when nitrogen dioxide sensor fitted. Reading can also be referenced to oxygen ppmn or mg/m3n.
- NOx : Calculated total nitric oxides displayed in ppm or mg/m3. Reading can also be referenced to oxygen ppmn or mg/m3n.
- SO2 : Sulphur dioxide reading in ppm or mg/m3. Displayed when sulphur dioxide sensor fitted. Reading can also be referenced to oxygen ppmn or mg/m3n.
- H2S: Hydrogen sulphide reading in ppm or mg/m3. Displayed when Hydrogen sulphide fitted. Reading can also be referenced to oxygen ppmn or mg/m3n.
- HC : Unburnt Hydrocarbon reading in % of LEL of methane, the sensor is calibrated with methane. Displayed when a Hydrocarbon sensor fitted. LEL is the Lower Explosive Limit of a gas when mixed with air, for methane this has the ratio of 19:1 Air:methane. Below the LEL the mixture can not ignite and burn. In the Flue an unburnt Hydrocarbons should be well below this level or there is the potential for an explosion.
- LOSS : Total losses calculated from Combustion Theory. This is the summation of the next three parameters.
- DRY : Calculated heat lost in turning the carbon in the fuel to carbon dioxide (CO2).
- WET : Calculated heat lost in turning the hydrogen in the fuel into water (H2O).
- CO LOSS % : Calculated loss due to partially burnt carbon. Any carbon monoxide (CO) in the flue has the potential to be turned into carbon dioxide and release more heat, hence this heat is lost up the flue.
- GPS (Y): Latitude DDMM.MMM 5148.1060
- GPS (X): Longitude DDDMM.MMM -00011.450
- ATM: Atmospheric pressure in mbar

B. NO_x CALCULATIONS

ONLY AN NO SENSOR FITTED

- WORKING IN PPM: NO_x REFERENCED TO NO

The user can select the assumed NO₂ percentage and the O₂ normalized level then: NO_x in ppm = NO in ppm multiplied by (1 + assumed NO₂ percentage) in this setup NO_x can only be displayed as NO_x = NO then normalizing:

NO in ppmn = NO in ppm multiplied by (21 minus the O₂ norm setting) and then divided by (21 minus the actual O₂ reading)

For a worked example assume:

NO is 1000ppm

NO₂ is 5% of NO

O₂norm is set to 3%

actual O₂ is zero

NO_x in ppm = 1000 x (1 +5/100) =1000 x1.05 = 1050 ppm

NO ppmn = 1000 x (21 - 3)/(21-0) = 1000 x 18 / 21 = 857 ppmn

NO_x ppmn = 1050 x 18 / 21 = 900 ppmn

or

NO_x ppmn = 857 x 1.05 = 900 ppmn

- WORKING IN MG/M3: NO_x REFERENCED TO NO OR NO₂

The user can select the assumed NO₂ percentage, the O₂ reference level and whether the NO_x reading is referenced to NO or NO₂

- WORKING IN MG/M3: REFERENCED TO NO

NO in mg/m³ = NO in ppm multiplied by 1.34

NO_x in mg/m³ = NO in mg/m³ multiplied by (1 + assumed NO₂ percentage)

- WORKING IN MG/M3: NO_x REFERENCED TO NO₂

NO_x in mg/m³ = NO in ppm multiplied by 2.05 multiplied by (1 + assumed NO₂ percentage)

or

NO_x in mg/m³ = NO in mg/m³ divided by 1.34, multiplied by 2.05 and multiplied by (1 +assumed NO₂ percentage)

- NORMALIZING READINGS

normalized reading = initial reading multiplied by (21 minus the O₂norm setting) and then divided by (21 minus the actual O₂ reading)

BOTH NO AND NO2 SENSORS FITTED

- **WORKING IN PPM: NO_x = NO + NO₂**

normalizing readings

ppm_n = initial reading in ppm multiplied by (21 minus the O₂ norm setting) and then divided by (21 minus the actual O₂ reading)

- **WORKING IN MG/M3**

The user can select how the readings are referenced.

NO_x = SUM

NO_x = NO

NO_x = NO₂

- **NO_x = SUM**

NO_x in mg/m³ = NO in ppm multiplied by 1.34 plus NO₂ in ppm multiplied by 2.05

- **NO_x = NO**

NO_x in mg/m³ = (NO in ppm plus NO₂ in ppm) multiplied by 1.34

- **NO_x = NO₂**

NO_x in mg/m³ = (NO in ppm plus NO₂ in ppm) multiplied by 2.05

- **NORMALIZING READINGS**

ppm_n = initial reading in ppm multiplied by (21 minus the O₂norm setting) and then divided by (21 minus the actual O₂ reading)

mg/m³_n = initial reading in mg/m³ multiplied by (21 minus the O₂norm setting) and then divided by (21 minus the actual O₂ reading)

ONLY AN NO2 SENSOR FITTED

When there is only an NO₂ sensor fitted the NO_x function is disabled

NO₂ in mg/m³ = NO₂ in ppm multiplied by 2.05

- **NORMALIZING READINGS**

ppm_n = initial reading in ppm multiplied by (21 minus the O₂norm setting) and then divided by (21 minus the actual O₂ reading)

mg/m³_n = initial reading in mg/m³ multiplied by (21 minus the O₂norm setting) and then divided by (21 minus the actual O₂ reading)

HIGH CO PURGE OPERATION

If there is a requirement to measure CO to concentrations above 10,000ppm then a High Purge module should be fitted (this comprises both a purge pump and a solenoid) in addition to the IR triple gas bench.

When the electrochemical sensor's reading passes 9800ppm the solenoid operates and the high purge pump switches on and pumps fresh air across the electrochemical CO sensor. The displayed reading changes at this point from ppm to % as measured by the IR module.

When the reading from the IR module falls below 0.95% the solenoid is deactivated and the high purge pump stopped. After a short time the displayed reading will revert to ppm. There may be a small perturbation in readings at the point of changeover.

C. COMBUSTION EFFICIENCY CALCULATION

The efficiency calculation is based upon British Standard BS845.

This identifies three sources of loss associated with fuel burning:

- LOSSES DUE TO FLUE GASSES:
 - Dry Flue gas loss,
 - Moisture and hydrogen
 - Sensible heat of water vapor
 - Unburned gas

- LOSSES DUE TO REFUSE:
 - Combustible in ash
 - Combustible in riddlings
 - Combustible in dust

- OTHER LOSSES:
 - Radiation
 - Convection
 - Conduction
 - Other unmeasured losses

Net efficiency calculations assume that the energy contained in the water vapor (formed as a product of combustion and from wet fuel) is recovered and the wet loss term is zero. Gross efficiency calculations assume that the energy contained in the water vapor is not recovered.

Since the fuel air mixture is never consistent there is the possibility of unburned/partially unburned fuel passing through the flue. This is represented by the unburned carbon loss.

Losses due to combustible matter in ashes, riddlings, dust and grit, radiation, convection and conduction are not included.

EFFICIENCY CALCULATION:

- KNOWN DATA

Fuel: Qgr = Gross Calorific Value (kJ/kg)

Qnet = Net Calorific Value (kJ/kg)

K1 = Constant based on Gross or Net Calorific Value:

$K1g = (255 \times \% \text{carbon in fuel}) / Qgr$

$K1n = (255 \times \% \text{carbon in fuel}) / Qnet$

K2 = % max theoretical CO₂ (dry basis)

K3 = % Wet Loss

- MEASURED DATA:

Tf = Flue Temperature

Ti = Inlet Temperature

O_{2m} = % Oxygen in flue gas

- CALCULATED DATA:

Tnet = Net Temperature

% CO₂ content in flue gas

% Dry Flue Gas losses

% Wet losses

% Unburned carbon loss

% Efficiency

$\%CO_2 = (20.9 - \%O_{2m}) \times K2 / 20.9$

Tnet = Flue Temperature - Inlet Temperature

Dry flue gas loss = $20.9 \times K1n \times (Tnet) / K2 \times (20.9 - \%O_{2m})$

Wet loss = $9 \times \%H_2 + \%H_2O / Qgr \times [2488 + 2.1Tf - 4.2 Ti]$

Simplified = $[(9 \times \%H_2 + \%H_2O) / Qgr] \times 2425 \times [1 + 0.001 Tnet]$

Wet loss = $K3(1+0.001 \times Tnet)$

Where K3 = $[(9 \times \%H_2 + \%H_2O) / Qgr] \times 2425$

Net Efficiency = 100% - dry flue gas losses

= $100\% - 20.9 \times K1n \times (Tnet) / K2 \times (20.9 - \%O_{2m})$

Gross Efficiency = 100% - {dry flue gas losses + wet losses}

= $100\% - [20.9 \times K1g \times (Tnet) / K2 \times (20.9 - \%O_{2m})] + [K3 \times (1 + 0.001 \times Tnet)]$

Excess Air = $[(20.9 / (20.9 - O_{2m}\%)) - 1] \times 100\%$

CO₂% = $[(20.9 - O_{2m}\%) \times K2\% / 20.9\%]$

Unburned fuel Loss = $K4 \times CO\% / (CO\% + CO_2\%)$

Where K4 = 70 for coke

= 65 for anthracite

= 63 for Bituminous coal

= 62 for coal tar fuel

= 48 for liquid petroleum fuel

= 32 for natural gas

The formula for K4 is based on the gross calorific value Qgr. To obtain the loss based on net calorific value multiply by Qgr/Qnet. Since this loss is usually small this conversion has been ignored.

OXYGEN REFERENCE

$$CO(n) = CO \times \frac{(20.9 - O2r)}{(20.9 - O2m)}$$

D. CALCULATION OF FUEL DATA

For any fuel not specified by Kane International the net calorific value, gross calorific value and composition should be obtained from the fuel supplier.

The following fuel data has been calculated with reference to the efficiency calculation.

Example 1:

Chemical composition:	C	25%
	H2	3%
	H2O	50%
	Qnet	8.35 MJ/kg
	Qg	9.3 MJ/kg *
	Max CO2	20.4%

$$\begin{aligned} K1n &= (255 \times \% \text{ carbon in fuel}) / Q_{net} \text{ (kJ/Kg)} \\ &= (255 \times 25) / 8350 = \mathbf{0.763} \end{aligned}$$

$$\begin{aligned} K1g &= (255 \times \% \text{ carbon in fuel}) / Q_g \text{ (kJ/Kg)} \\ &= (255 \times 25) / 9300 = \mathbf{0.685} \end{aligned}$$

$$K2 = \text{Max \% CO}_2 = \mathbf{20.40}$$

$$\begin{aligned} K3 &= \text{Wet Loss} = [(9 \times \%H_2 + \%H_2O) / 9300] \times 2425 \\ &= [(9 \times 3 + 50) / 9300] \times 2425 \\ &= (77 / 9300) \times 2425 = \mathbf{20.08} \end{aligned}$$

$$K4 = \mathbf{65} \text{ (an approximation for wood) }^*$$

The fuel values to program into the Analyzer are as follows:

NATURAL GAS			
K1g	: 0.763	K1n	: 0.685
K_2	: 20.4	K_3	: 20.08
K_4	: 65	O2r	: 8.0

* Assumed values in the absence of supplied data. See previous appendix for other fuels.

E. ELECTROMAGNETIC COMPATIBILITY (CE) STATEMENT



This product has been tested for compliance with the following generic standards:

EN 61000-6-3 : 2011

EN 61000-6-1 : 2007

and is certified to be compliant.

Specification

EC/EMC/KI/K9206 details the specific test configuration, performance and conditions of use.

SAFETY STANDARD

This product complies with the EN61010 Safety Standard (Safety requirements for electrical equipment for measurement, control and laboratory use):

EN61010-1 : 2010

Protection Class 3 (SELV)



K9206

Quintox Flue Gas Analyzer

Limited Warranty

The K9206 is warranted to be free from defects in materials and workmanship for a period of one year from the date of purchase. If within the warranty period your instrument should become inoperative from such defects, the unit will be repaired or replaced at UEi's option. This warranty covers normal use and does not cover damage which occurs in shipment or failure which results from alteration, tampering, accident, misuse, abuse, neglect or improper maintenance. Batteries and consequential damage resulting from failed batteries are not covered by warranty. Annual calibration is not covered as a warranty item.

Any implied warranties, including but not limited to implied warranties of merchantability and fitness for a particular purpose, are limited to the express warranty. UEi shall not be liable for loss of use of the instrument or other incidental or consequential damages, expenses, or economic loss, or for any claim or claims for such damage, expenses or economic loss. A purchase receipt or other proof of original purchase date will be required before warranty repairs will be rendered. Instruments out of warranty will be repaired (when repairable) for a service charge.

For more information on warranty and service:

1-800-547-5740 • FAX: (503) 643-6322
www.ueitest.com • Email: info@ueitest.com

This warranty gives you specific legal rights. You may also have other rights which vary from state to state.

Para la versión en español de este manual por favor visite www.ueitest.com

Pour une version française du manuel de l'utilisateur s'il vous plaît visitez www.ueitest.com

